

FEATURES	
Technology	POS (Per Outlet Switching)
Energy Metering	Voltage(V), Current(A), Active Power(W), Apparent Power (VA), Reactive Power (var), PF, Frequency(Hz), kWh
Metering per Input Line	Yes (Branch Circuit and Total Current) Accuracy 1%
Metering per Output Receptacle	No
Remote Outlet Switching	Yes
Ethernet Port	2 Gigabit Ethernet ports to access the PDU from 2 different networks
Networking Protocols	DHCP, IPv4 and IPv6, DNS, http / https, SSHv.2, SNMP v1 / v2c / v3, SNMP TRAPS / SETS / GETS, SMTP, Modbus , TCP, RADIUS, Syslog, TLS 1.3, SNTP, ARP, ICMP, ICMPv6, UDP, NDP
PDU Cascading	16 PDUs
Power Share	Yes
Network Controller	Replaceable Hot Swapable controller with 4 button OLED display
Residual Current Monitoring	No
Rack Acces Control	Compatible with DCIM solutions
USB Ports	2 USB A ports WiFi networking,webcam,PDU configuration and mobile interface
Environmental Sensors	All in one Temperature and Humidity sensor with 2 digital inputs (for connect air flow, door sensor, water leak, smoke detector and Vibration sensor) plug and play bus allows to connect 8 EMD devices in one PDU
INPUT	
Plug	IEC60309 3P+N+E 6h 32A 380-415V
Lead Length	3 meter
Cable Type	H07RN-F5G4.0 mm <sup>2</sup>
Max. Input Load	32A
Rated Input Voltage	380-415V three phase
Frequency	50-60Hz
Power Capacity	22.1kW
OUTPUT	
Rated Output Voltage	190-250V Single phase
Output Types	24 IEX (C13/C19) combo with LED (Max rate 16A) EN61984+UL498 certified
Overload Protection	(6) 1 Pole Carling 16A J Series J51-BO-24-616-M1D-D3
CHASSIS	
Dimensions (W x D x H)	1832 x 60 x 72 mm
Color	RAL 9004 black powder coat
Mounting Options	4 mounting options (see page 2)
Required Torque for Mounting Screws	≥2.54N·m (25.9kgf·cm or 22.4 in·lbs)
OPERATING ENVIRONMENT	
Temperature Range	0° to 60° C (30° to 140° F)
Humidity	0 - 95 %
Elevation	0 - 4000 Meters
CONFORMANCE	
IEC 62368-1 (Third Edition)	

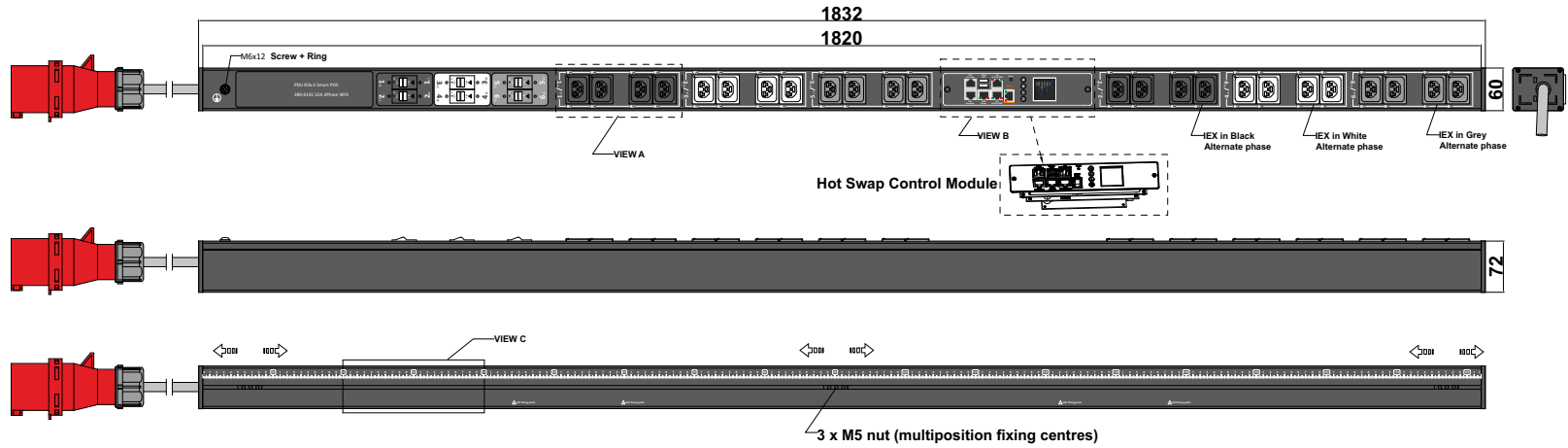

VIEW B:

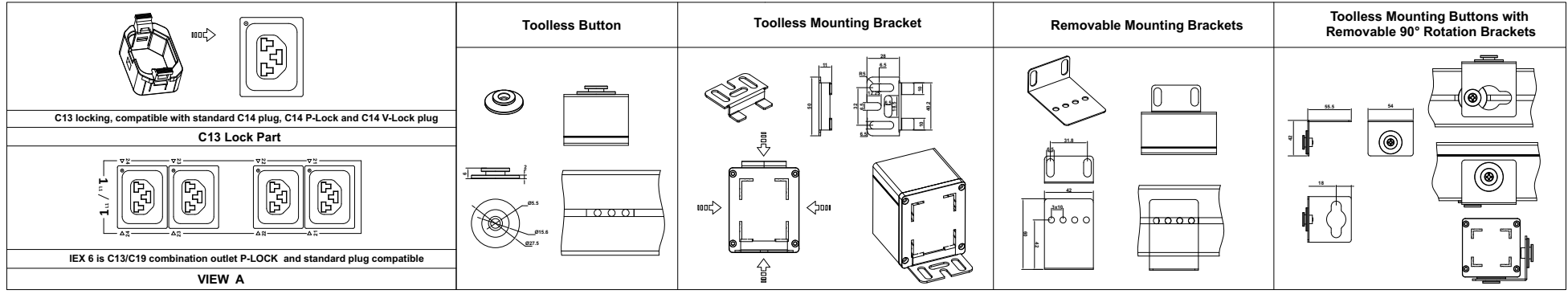
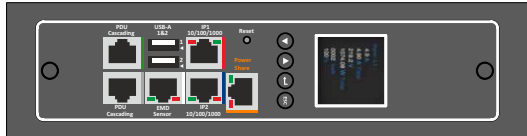

VIEW C:

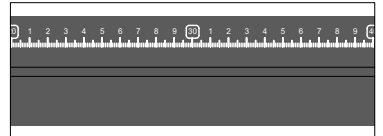



Chassis Color	Code
Black	Standard color
White	W
Red	R
Blue	A
Green	G
Orange	O
Grey	GY
Yellow	Y

Packing content:

IEX Lock-VP  X24 (black,white,grey)

<p><b>POS Series</b></p> <p>Inlet Power Monitoring Per Outlet Switching Environmental Monitoring</p>	<p><b>OUTPUT</b></p> <p>(8) IEX (C13/C19) combo with LED Black (Max rate 16A) (8) IEX (C13/C19) combo with LED White (Max rate 16A) (8) IEX (C13/C19) combo with LED Grey (Max rate 16A)</p>	<p><b>OPERATING TEMPERATURE</b></p> <p>0° to 60°C</p>	<p><b>INPUT</b></p> <p>380-415VAC 32A 50HZ IEC60309 32A 3P+N+E Plug 3m H07RN-F5G4mm<sup>2</sup> Power Lead</p>	<p><b>BRANCH CIRCUITS</b></p> <p>(6) 1 Pole Carling 16A J Series J51-BO-24-616-M1D-D3</p>	<p><b>MOUNTING ACCESORIES</b></p> <p>(2) Toolless Button (2) Toolless Mounting Bracket (2) Removable Mounting Brackets (2) Toolless Mounting Buttons with Removable 90° Rotation Brackets</p>

Revisions		
Rev	Description	Date

<p>DRAWING TYPE</p> <p></p> <p>(NO PERMISSION, NO CHANGING)</p>	<p>DN-POS-24IEX-3F32A-V</p>	
<p>unit=mm</p>	<p><b>Housing</b></p> <p>Aluminium Black Powder Coating RAL9004</p>	<p></p> <p>DATE 04-01-2023</p>
<p>TECHNICAL STANDARD IT11; NO RUST NO FLAW ON THE SURFACE</p>		
<p>FILLET R0.5</p> <p>ANGLE ±0.5°</p> <p>FIRST ANGLE</p> <p></p>		

- Low cost locking solution t both ends
- Different colors available
- Patented IEX locking system
- Locking sleeve for C13 and C19 plugs
- VDE, UL approved

# IEX PATENTED LOCKING SOCKET - POWER CORD SOLUTION



## C14 - C13 Sleeve

H05VV-F3G1 mm<sup>2</sup>

Color	0,5M	1M	2M
Black	✓	✓	✓
Red	✓	✓	✓
Blue	✓	✓	✓

## C14PLOCK - C13 Sleeve

H05VV-F3G1 mm<sup>2</sup>

Color	0,5M	1M	2M
Black	✓	✓	✓
Red	✓	✓	✓
Blue	✓	✓	✓

## C20PLOCK - C19 Sleeve

H05VV-F3G1,5 mm<sup>2</sup>

Color	1M	2M
Black	✓	✓
Red	✓	✓
Blue	✓	✓

## C20PLOCK - C13 Sleeve

H05VV-F3G1 mm<sup>2</sup>

Color	1M	2M
Black	✓	✓
Red	✓	✓
Blue	✓	✓

**Meter Board**

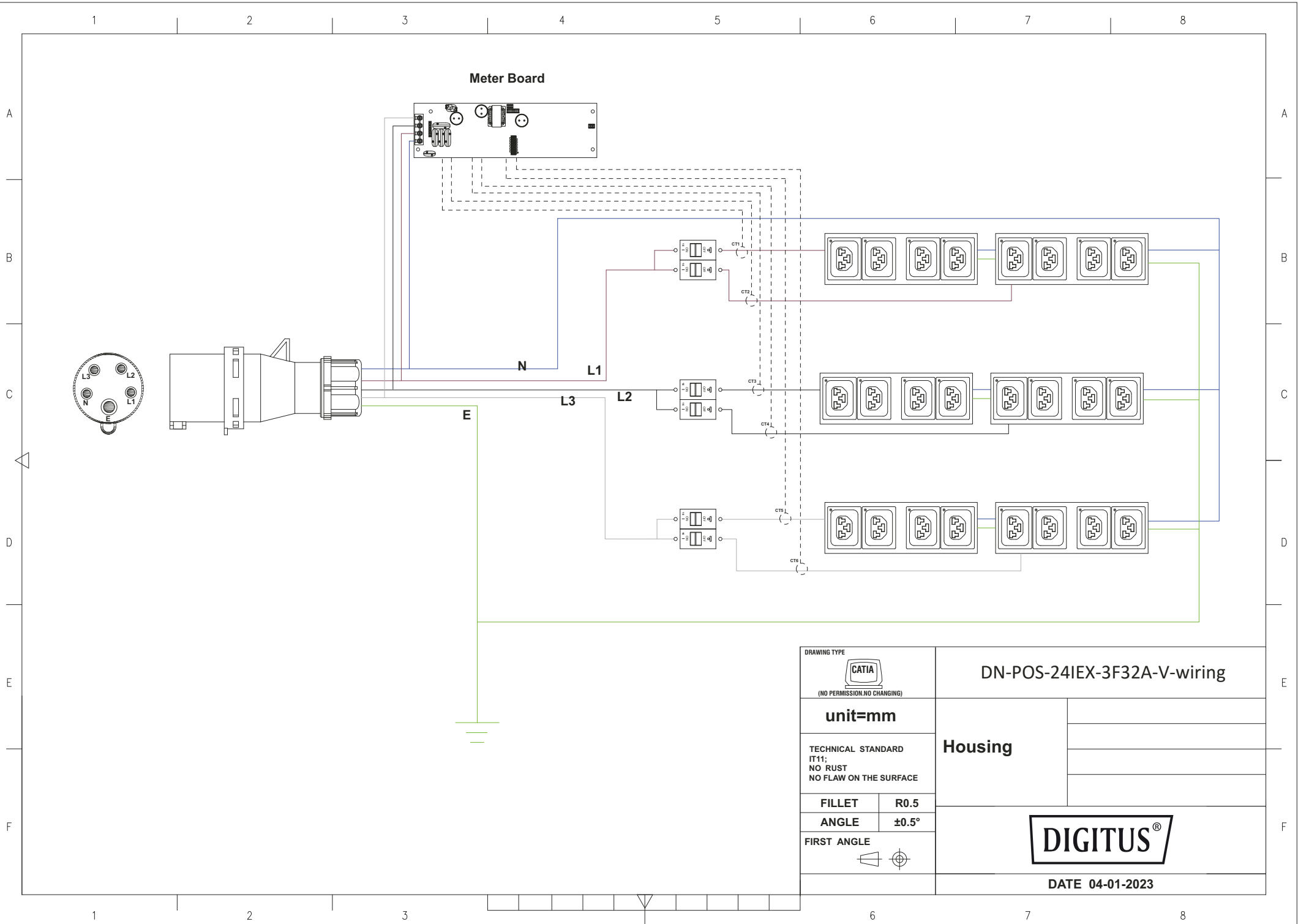

DRAWING TYPE  
  
 (NO PERMISSION, NO CHANGING)

DN-POS-24IEX-3F32A-V-wiring

unit=mm

Housing

TECHNICAL STANDARD  
 IT11;  
 NO RUST  
 NO FLAW ON THE SURFACE

FILLET R0.5

ANGLE ±0.5°

FIRST ANGLE  



DATE 04-01-2023

QTY	Part No.
1	PD090-3

Part No.  
PP029-3

Part No.  
PP081-6

Part No.  
PP070-5

Part No.  
PP030-4

QTY	Part No.
8	IEXLOCKB
8	IEXLOCKW
8	IEXLOCKG

QTY	Part No.
2	MT190

QTY	Part No.
2	MT124-1

QTY	Part No.
2	PL178

QTY	Part No.
2	MT124-1

QTY	Part No.
2	MT190-2

QTY	Part No.
6	MT124

QTY	Part No.
2	PL178

QTY	Part No.
2	MT190-3

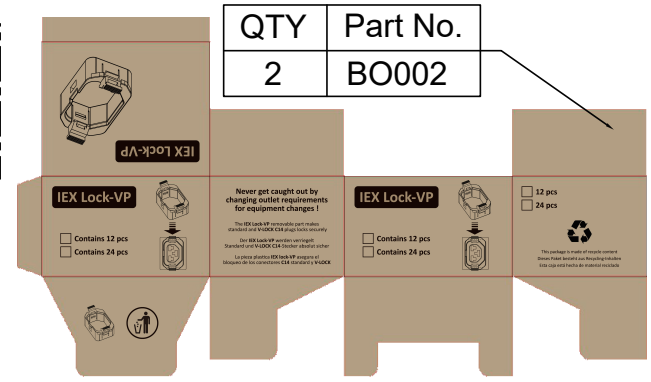

**PK037**  
Section 23.5x9 cm Length 220 cm

**Weight: 10kg(2 PDU)**